

Ruppert Musical Instruments

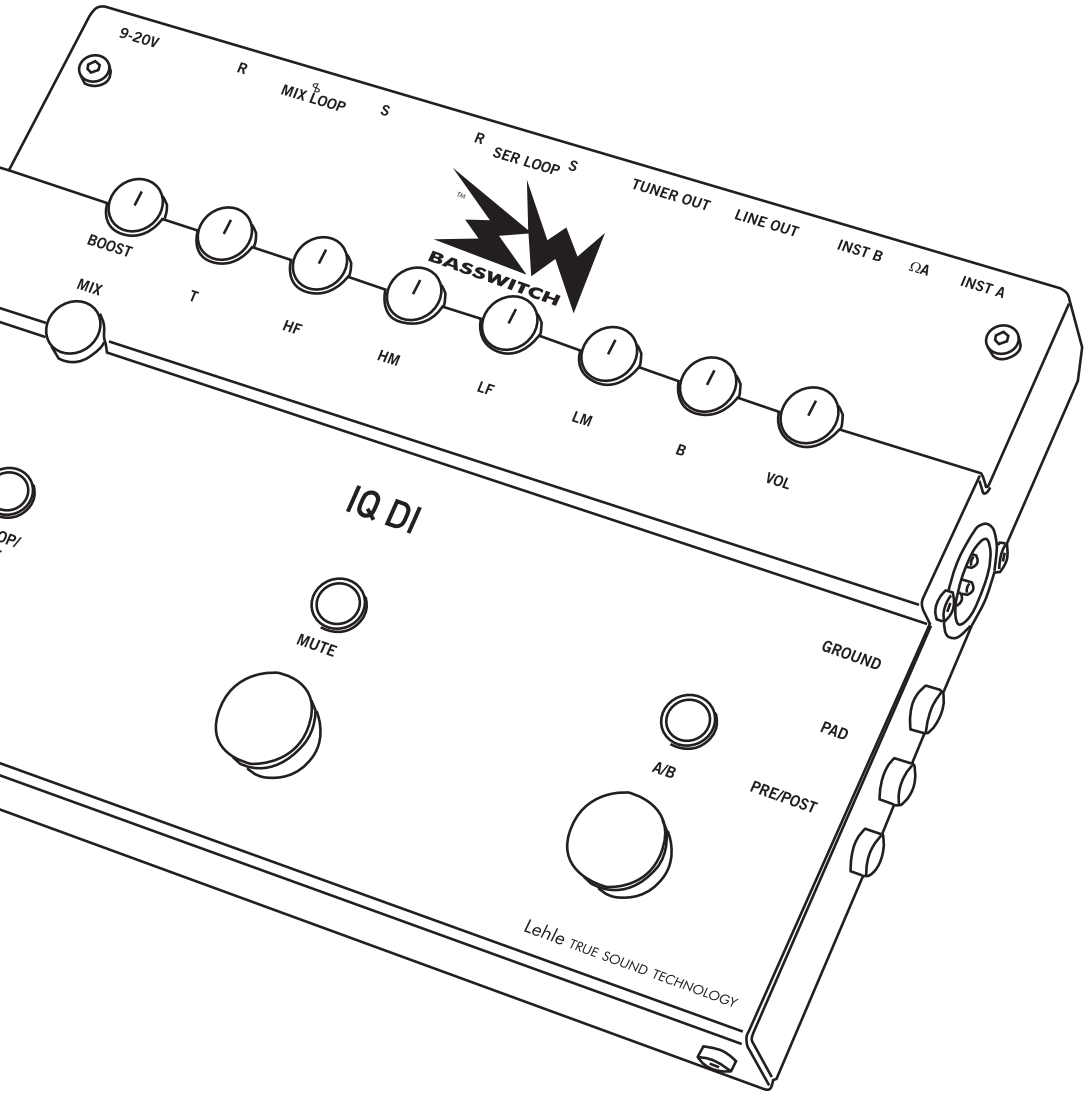

User Manual

Congratulations!

With the Basswitch IQ DI you have purchased a high-quality piece of musical equipment that will open up new dimensions in bass-signal amplification and routing and give you the confidence that you are adequately prepared for any situation, be it in live performance or in a recording studio.

When developing the Basswitch IQ DI we focused on the needs and wishes of the professional bass player who is not willing to compromise on either sound or the technical quality of the equipment. The Basswitch IQ DI is manufactured, assembled and tested in Germany to the highest quality standards using only the best brand components available to ensure optimal treatment of the electrical signal from your instrument.

Thanks to its variable input impedance, the Basswitch IQ DI is an all-rounder, equally suitable for electric and acoustic instruments. Whether the signal comes from a magnetic or a piezo pick-up, the high-end preamp of the Basswitch IQ DI will ensure that their specific characteristics are uncompromised.

The Basswitch IQ DI has been designed to offer bass players an „all-in-one” solution whether used in stand-alone mode or as the control centre of a pedal-board. It is an A/B-input switcher, a high-end pre-amp, a clean booster, a parametric EQ, an FX loop switcher and last but not least a professional-quality D.I. box. It is the only

product on the market that provides all these functions and potential applications in a single compact unit. The Basswitch IQ DI is a Swiss Army knife that should be part of the equipment of every demanding bass player.

Please take your time to read this user manual carefully before you start using your Basswitch IQ DI. You will find lots of useful information on the pedal and the various ways it can be used. Keep this user manual carefully so that you can consult it at any time.

Your Basswitch IQ DI package contains the following items:

- Bassswitch IQ DI
- Optimised connector for the power supply socket
- 4 plates for mounting on a pedal-board etc.
- User manual

Please check that all these items are there as soon as you unpack. Should something be missing, please contact your authorised dealer.

The Basswitch IQ DI is built to last, but if you nonetheless experience problems or have any questions do not hesitate to contact us.

I wish you every success with your Basswitch IQ DI.

Yours,
Jacques Ruppert

P.S.: On our website www.bassswitch.com you can find practical examples of how you can use your Basswitch IQ DI and a whole range of sample settings for the parametric EQ – a treasure house for all sorts of bass sounds that we will go on expanding!

Summary

Introduction	4
Description	6
Examples of possible set-ups	13
Tech Talk	15
Technical data	18

Introduction

Why a specific preamp-/looper-/DI-pedal for bass instruments? The reasons are obvious: the frequency range of bass instruments goes from very deep fundamentals (e.g. 30.87 Hz for low B or 41.20 Hz for low E on an electric bass) to very high overtones that have a crucial impact on the timbre of the bass instrument even though they are approaching the upper limits of the audible spectrum (from 18 Hz to 20 KHz). On top of this, bass instruments have a characteristic attack with a very steep initial transient followed by a weak electrical signal. These characteristics of bass signals make enormous demands on the electronics, with the result that the handling of bass signals by most equipment is unsatisfactory and inconsistent in quality. Only equipment specifically designed for the purpose is able to handle such a demanding signal pattern adequately. The advantage of the Bassswitch IQ DI, which meets these demands, is that it can also be used in many other areas (e.g. to handle the signals from acoustic instruments).

Functions and applications overview

- The Bassswitch IQ DI as A/B input switcher

Input „Instrument A” allows you to connect either a low-impedance instrument (e.g. passive or active electric bass) or a high-impedance instrument (e.g. piezo-pickup of an electric bass or double bass or other acoustic instruments without preamp). Input „Instrument B” allows you to connect a second instrument. The A/B footswitch permits toggling between the two inputs, whereby the signal from input A is routed to Channel A of the pedal and the signal from input B is routed to Channel B. If no cable is connected to the

„Instrument B” input, the signal from Instrument A can be routed to Channel A or Channel B by using the A/B footswitch.

- The Bassswitch IQ DI as high-end preamp with parametric EQ

Channel A of the Bassswitch IQ DI features a high-end preamp and a 4-band EQ specifically designed for bass instruments and featuring bass, semiparametric low- and high-mids, and treble controls. This means you can either efficiently match the sound and volume of two instruments connected to the Bassswitch IQ DI or have a second sound-setting for a single instrument available at the push of a switch. Alternatively you can use the pedal, together with its other features, as a flexible high-end preamp. As a stand-alone preamp, the Bassswitch IQ DI can drive a power amp, an active monitor, an active bass speaker cabinet or an in-ear monitoring system. Note: The design of Channel B follows the philosophy of not routing the instrument signal unnecessarily through electronics but leaving it as pure and natural as possible. Channel B therefore has neither a preamp nor an EQ. If two instruments are connected to the Bassswitch IQ DI, the matching of the volume is done exclusively via the controls on Channel A. The Channel A preamp therefore has a volume cut and boost function.

- The Bassswitch IQ DI as FX Looper

The Bassswitch IQ DI has two effect loops: a passive serial loop and a switchable infinitely variable mixing loop, that enables you to go from a completely dry signal (100% original; 0% FX), via parallel (100% original; 100% FX) to FX-only (100% FX; 0% original). A phase-inverter

ensures that any out-of-phase signals do not cancel each other out in parallel mode.

- *The Basswitch IQ DI as a real clean booster*

A footswitch and a volume control allow you to add a second high-end amplification stage upstream of the Mix Loop. This can be used to provide tracking - or overdrive/distortion pedals with an adequate input signal. If the Mix Loop is not used, the booster serves as a real clean solo booster.

- *The Basswitch IQ DI as a D.I. box*

The Basswitch IQ DI can be used to send the output signal directly to a mixing console. The high-quality components and features of the Basswitch IQ DI (high-end preamp, Lehle transformer, ground-switch, pre/post signal-processing switch, pad for output attenuation, rugged construction) make the Basswitch IQ DI an excellent D.I. box, be it in a live setting or in the studio.

Note: Although the Basswitch IQ DI was not originally designed for this application, it can also be used as a line mixer. To do this, the return socket of the Mix Loop

is used as input and the ratio of this signal to the signals coming from inputs A and B is adjusted by using the mix control. (The signal from the return input of the Mix Loop cannot, however, be muted and is not available at the Tuner Out).

Additional features

- Tuner Out: Connect your tuner here to keep it out of the signal path and prevent potential sound losses. This way the tuner can be on all the time allowing you to check your tuning „on-the-fly”.
- Lehle „True Sound Technology” (for details please consult the chapter „Tech Talk”).
- Specially designed to protect the controls from damage and to prevent inadvertent changes to the settings.
- The design of the housing permits easy installation: the ultra-flat base and removable rubber feet allow the unit to be securely attached to the pedal-board using Velcro or similar. Alternatively, the Basswitch IQ DI can be permanently fixed to the pedal-board using the mounting plates included.

Description

6

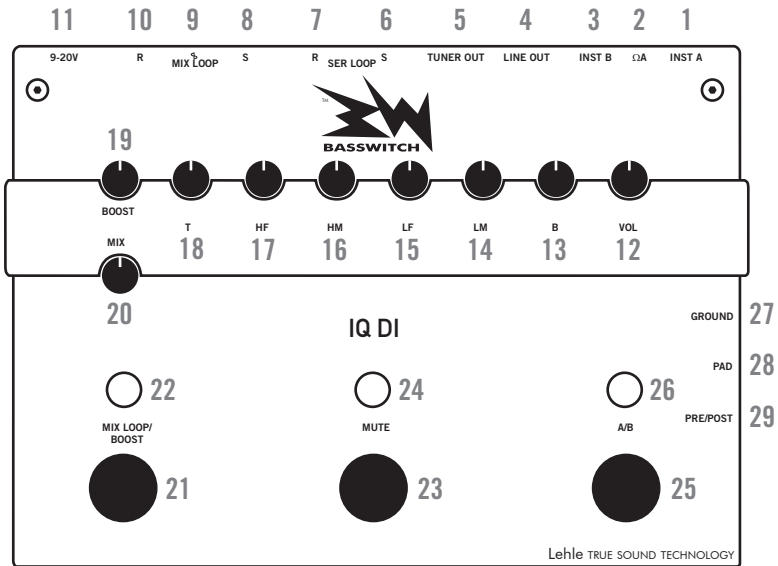

1. Input INST A

Connect your first instrument here.

This is the standard input for all instruments. The input is designed to accept active and passive instruments. You can also connect instruments with piezo or other high-impedance pick-ups; to do this, you can raise the impedance from 1 MΩ to 10 MΩ with the adjacent ΩA switch.

When using this input you can use the A/B switching function irrespective of whether an instrument is connected to input INST B. If an instrument is only connected to input A the A/B footswitch toggles Input A between Channel A and Channel B.

Note: Please note the distinction between „input selection – A or B” and „internal routing – via Channel A (preamp/EQ) or Channel B (straight through)”. See also point 25.

2. ΩA Switch

This switch enables you to change the impedance of Input A from the standard 1 MΩ to 10 MΩ permitting the direct connection of instruments with piezo pick-ups or similar. The impedance should be raised to 10 MΩ only if the instrument is not equipped with an internal preamp for the piezo pick-up or if the internal preamp can be defeated. If the internal preamp can be defeated we recommend that you use the high-end preamp and parametric EQ of the Bassswitch IQ DI instead. In most cases using the preamp/EQ section of the Bassswitch IQ DI will give better results.

Note: The ΩA switch is “off” (1 MΩ) in the „up” position and “on” (10 MΩ) in the „down” position.

3. Input INST B

Connect your second instrument here.

This is the optional input for a second instrument. Should you wish to use two instruments using the same cable you must use Input A and Input B is not used.

Note: If you use only one cable for two instruments we recommend that you use the mute function (23) together with the A/B function when switching instruments.

4. LINE OUT

Connect your bass amp or power amplifier or active monitor here.

If the Bassswitch IQ DI is used upstream of a bass amp, it should be in “straight through” mode (Channel B active – LED white – Loop/Boost function off – no LED-effects in serial loop off, except for those that stay on all the time) and the settings for the basic sound should then be made on the amplifier.

Channel A can be used either to match the sound and volume of your second instrument as needed with the aid of the pre-amp and the highly effective EQ or, if only one instrument is being used, to create a second sound, available at the push of a footswitch.

If the Bassswitch IQ DI is used as a pre-amp upstream of a power amp or an active monitor Channel A must be used (blue LED) and the basic sound set up using the preamp/EQ section of the Bassswitch IQ DI.

Note: Make sure that in this case too the Loop/Boost functions are off (LED off) and that the effects in the serial loop are off, except for those that stay on all the time) when setting up your sound.

5. TUNER OUT

Connect your tuner here.

Connecting your tuner here guarantees that the tuner is completely out of the sig-

nal path and does not cause sound losses. It allows you to keep your tuner on all the time so that you can check of your tuning and intonation control on the fly.

To defeat the sound while tuning use the mute button (23) on the Bassswitch IQ DI. The mute button defeats both the Line Out and the D.I. Out.

6. SEND Output (Serial Loop)

Connect the first effect(s) you want to run in the serial loop here (see below!).

The main purpose of the passive serial loop is to connect to the Bassswitch IQ DI devices that will be on all the time. Typical examples are volume pedals, tone exciters or compressors.

You can also use this loop to create an additional FX Loop to complement the switchable Mix Loop. This is however only advisable if the effects used are equipped with a high-quality bypass (see the talk section at the end of this manual) and are very low-noise. In case of doubt, we recommend that for this type of use you insert a looper pedal (e.g. Lehle D.Loop SGoS or Lehle Parallel L) between the serial loop and the effects that are not intended to stay on all the time.

7. RETURN Input (Serial Loop)

Connect the output of the last of the effect(s) connected to the Send output of the serial loop here.

8. SEND Output (Mix Loop)

Connect the first effect(s) you want to run in the Mix Loop here.

The Mix Loop is the standard loop signal path of the Bassswitch IQ DI. It has several additional features (mixer function – see Point 20 – out-of-phase switch, and cut/boost function) that allow you to op-

timise the signal routing in the Mix Loop. The order of effects depends on the taste of the individual user and the application environment, but in case of doubt we recommend the following order for bass instruments: octaver - overdrive/distortion - envelope-filter – chorus/flanger – tremolo – delay – reverb.

Note: The loop path is located after the mute-function; this means that for instance an echo will be heard fading away even if the pedal is muted.

9. Out-of-phase switch PHASE (Mix Loop)

Invert the phase of the return-signals of your effect here if needed.

When mixing the original signal with the return-signal from the effect the two signals may cancel each other out under certain circumstances. Most commonly the sound will be described as “thin” in these cases. Inverting the phase solves this problem. Under most circumstances this switch will be in the “off” position (up = in phase). To invert the phase put the switch in the down position.

Note: It is ultimately for the user of the Bassswitch IQ DI to decide what sounds better for the given circumstances. Just try it out and decide what sounds best to you.

10. RETURN Input (Mix Loop)

Connect the output of the last of the effect(s) connected to the Send output of the Mix Loop here.

If the Return input is not in use, the Mix Loop button works as a clean booster (see also Point 21).

Note: Use a TRS jack (Tip Ring Sleeve) to obtain a symmetrical return input and a normal jack for an asymmetrical connection.

11. External power supply

Connect your external power supply here (9-20V; min. 130mA).

Because of the uncompromising design, the quality of the components, the large number of functions and the switching technology used, the power consumption of the Bassswitch IQ DI is too high for it to run satisfactorily on batteries.

The external power supply should provide not less than 9V and not more than 20V. Either alternating (AC) or direct current (DC) sources can be used and the polarity is not relevant. The voltage supplied is internally rectified, filtered, stabilised and then brought to 18V. A suitable connector for the Bassswitch IQ DI power supply socket is included and can be soldered to the external power supply connection cable if needed.

Note: To get the best out of your pedal set-up we recommend that you use high-quality power supplies with isolated output sections in your set-up!

12. VOLUME Control (Channel A)

Use this control to adjust the volume of channel A.

This control adjusts the volume of Channel A. To permit optimal matching of the volume between Channel A and Channel B this control enables you to boost and to cut the signal, the neutral position is at 12 o'clock. The high-end preamp of the Bassswitch IQ DI allows you to connect the Bassswitch IQ DI directly to a power amp (see also point 4).

13. BASS Control (Channel A)

Use this control to adjust the amount of bass in your tone.

This control has been designed with the deepest frequencies of the bass instru-

ments in mind to permit a targeted cut and boost of these frequencies. This control is very useful with passive basses, for instance, to give them more depth and substance. The technical design used enables a good sound to be maintained even when applying major adjustments to the signal, but we suggest that you use this control with care to avoid a bass-heavy sound.

14. LM Control (Low Mid Gain)

Use this control to adjust the amount of low mids in your tone.

This control boosts and cuts the lower mids. The exact frequency to be cut or boosted is specified by means of the adjacent low-mid frequency control to the left of the LM control. The technical design used enables a good sound to be maintained even when applying major adjustments to the signal, but we suggest however to use this control with care, the intention being more to subtly modify the sound than to fundamentally change it.

15. LF Control (Low Mid Frequency)

Use this control to select the low mid frequency you want to adjust.

To select the frequency you want to adjust we suggest you proceed as follows: To find the frequency, first turn the gain control clockwise to maximum, then search for the frequency that you want to cut or boost by slowly turning the frequency control from full-left to full-right whilst playing.

The low-mid EQ will help you to create many bass sounds like the famous „Fat Finger Tone” or classic rock and reggae sounds. Boosting the deeper low mids will help the bridge pickup of an electric bass to sound deeper, while boosting the upper low mids will bring you punch and help you

to cut through the mix. When confronted with poor speaker cabinets it will help you to attenuate the undesirable “honk” of the speaker by cutting the corresponding frequency. Last but not least, targeted cutting of the appropriate frequency will help to fight feedback with acoustic instruments such as the double bass.

16. HM Control (High Mid Gain)

Use this control to adjust the amount of high mids in your tone.

This control boost and cuts the higher mids. The exact frequency to be cut or boosted is specified by means of the adjacent high-mid frequency control to the left of the HM control.

17. HF Control (High Mid Frequency)

Use this control to choose the high-mid frequency you want to adjust.

Selecting the frequency to be cut or boosted is done in the same way as for the low mids (see Point 15). The high-mid EQ enables you to create interesting sounds like the classic slap sound („Slappers delight”). Boosting the upper mids brings life to dull speaker cabinets and new life to old strings. When using new strings, especially new round-wound steel strings you can get the aggressive highs under control by cutting the appropriate upper frequencies a little. It can also help, if needed, to reduce the annoying rattling of the strings.

18. TREBLE Control

Use this control to adjust the amount of treble/presence in your tone.

The treble control cuts or boosts the upper frequencies of your tone.

Note: The treble control is designed to create the desirable „upper sizzle” in your

sound. The so-called “treble” frequencies of the bass instrument are adjusted in the upper mid section (see also point 17).

19. BOOST Control (Mix Loop)

Use this control to adjust the Mix Loop send level or the solo boost level.

This control has a double function depending on whether the Mix Loop is used or not. If the Mix Loop is in use (effects connected) this control allows you to adjust (cut or boost) the signal level sent to the input sensitivity of the effects in the Mix Loop. This is very useful if you use effects that are sensitive to the dynamic of the input signal (the Bassswitch operates at twice the dynamic level of a standard effect pedal and may cause some pedals to distort), or to overdrive older pedals, especially distortion units.

If the Bassswitch IQ DI is used in stand-alone mode this control is used to set the level for solos or louder passages.

Note: If the Mix Loop is used as a booster the mix control (20) should be turned fully to the left (clockwise)!

20. MIX Control

Use this control to adjust the amount of effect signal from the Mix Loop that you want in your signal.

Many effect pedals, especially older ones, do not let you mix the basic sound of your instrument and the effect sound. At the same time many effect pedals destroy the powerful bass component in the signal and the result is an unattractive, thin sound. The mix control addresses this problem by enabling you to add exactly as much effect to the original basic sound as you want. With the control turned fully to the right, the effect signal is turned off and you have 100% original signal. The mid-position (6

o'clock) corresponds to a parallel effect loop (100% original/100% effect). Turned fully to the right (clockwise), the control turns off the original signal leaving you with 100% effect signal, which corresponds to a serial loop.

21. MIX LOOP/BOOST Footswitch

Press this switch to activate the Mix Loop and/or the solo booster.

This footswitch is used to switch the mix-loop channel on or off. If no jack is connected to the mix-loop return, it is used to boost the signal for solos or louder passages.

22. MIX LOOP/BOOST status LED

The LED turns blue when the Loop/Boost function is turned on.

23. MUTE footswitch

Push this switch to activate the mute function for tuning or stand-by.

Pressing this footswitch mutes the Line Out and D.I. Out and allows for quiet tuning or a quiet change of instruments when only one cable in Channel A is used. It also serves as stand-by mode switch.

Note: The return signal of the Mix Loop is not muted by this function. Take this into consideration to avoid surprises with long delays or loop stations.

24. MUTE status LED

This LED comes on when the Loop/Boost-function is turned on.

25. A/B footswitch

This footswitch serves to toggle between input INST A and input INST B and between Channel A and Channel B of the Bassswitch IQ DI if only input INST A is in use (see also Point 1).

If input INST A and input INST B are both being used the footswitch toggles between input A and input B and input A is routed to Channel A while input B is routed to Channel B.

If only Input A is being used the footswitch toggles the Input A signal between Channel A and Channel B. This allows to set up your basic sound on your amp using the „straight-through” Channel B and to have a second sound-setting available by pressing the footswitch, either for a second instrument or for a change of style (such as from fingerstyle to slap or plectrum).

26. A/B status LED

This LED shows the status of the A/B function (Blue = input INST A or Channel A; white = input INST B or Channel B).

27. GROUND button

Press the ground button to eliminate hum.

If the ground switch is not pressed the in-built Lehle-transformer ensures galvanic isolation between the shielding of the Bassswitch IQ DI und the earth conductor of the XLR cable attached. If this setting generates hum, activating the ground switch may solve the problem. When the ground button is pushed, the shielding of the Bassswitch IQ DI and the earth conductor of the XLR cable are connected. If in doubt a „trial-and-error” approach is recommended to identify the position that generates less noise.

28. PAD button

Push the pad button to attenuate the output signal.

The D.I. output is designed to match the line input of any mixing console. If the mixing desk does not offer line inputs you may

use the more sensitive mic input of the mixing desk after pressing the pad button to attenuate the output of the Bassswitch IQ DI to match the microphone input of the mixing desk.

29. PRE/POST pushbutton

Press the pre/post button to take the EQ and the effect loops out of the D.I. signal path.

With the „pre” setting the signal is routed directly to the D.I. Out without going through the EQ and the loops. The Line Out routing remains unaffected.

Note: In a recording situation it is preferable to record the bass instrument signal as is and to add effects at a later stage. The design chosen here for the „pre” function allows the musician to hear his signal with EQ and effects as he is used to via the Line Out, while at the same time the unprocessed signal is taken directly after the volume control of Channel A or the buffer of Channel B and sent to the mixing console via the D.I Out. Effects can then be added during the mix by means of re-amping, which generally gives better results.

30. D.I OUT

Use the D.I. OUT to connect to a mixing desk via an XLR cable.

The D.I. OUT of the Bassswitch IQ DI is designed to match the line input of any mixing console. If no XLR line inputs or only low-impedance microphone inputs are available on the mixing desk, however, press the PAD button (28) to attenuate the level of the Bassswitch IQ DI output.

Note: Obviously, the D.I. OUT and the LINE OUT can be used at the same time so that the Bassswitch IQ DI signal can be sent to both a power amp or bass amp (via LINE OUT) and a PA or recording console (via D.I. OUT).

Examples of possible set-ups

1. The Bassswitch as a Preamp/Booster/DI in standalone mode

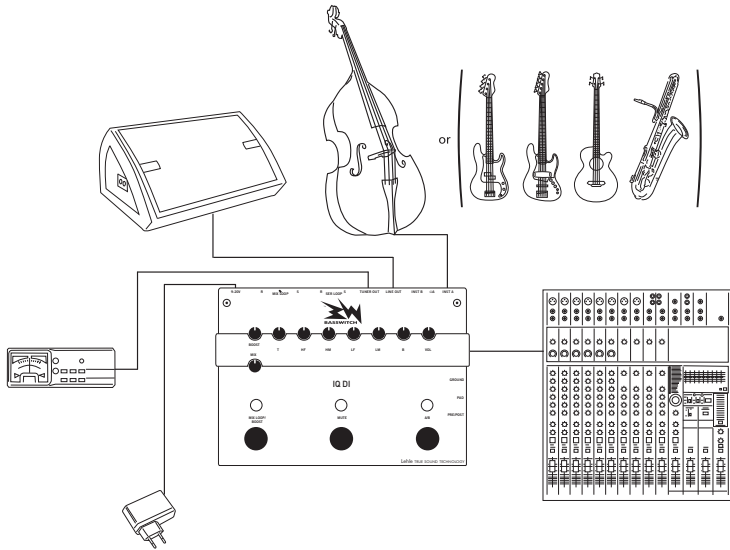

12

2. The Bassswitch as a Preamp/Looper/DI on a pedalboard

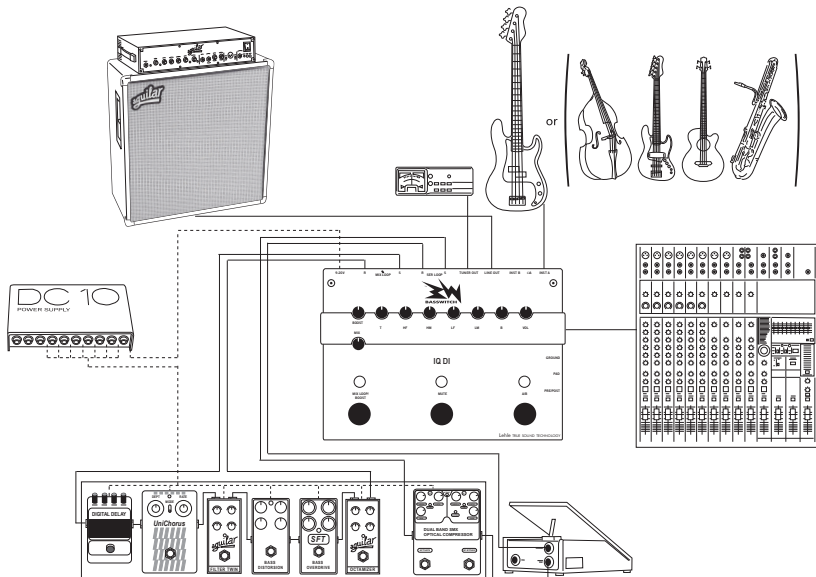

3. The Bassswitch as an AB Switcher/Preamp/Booster/DI in standalone mode

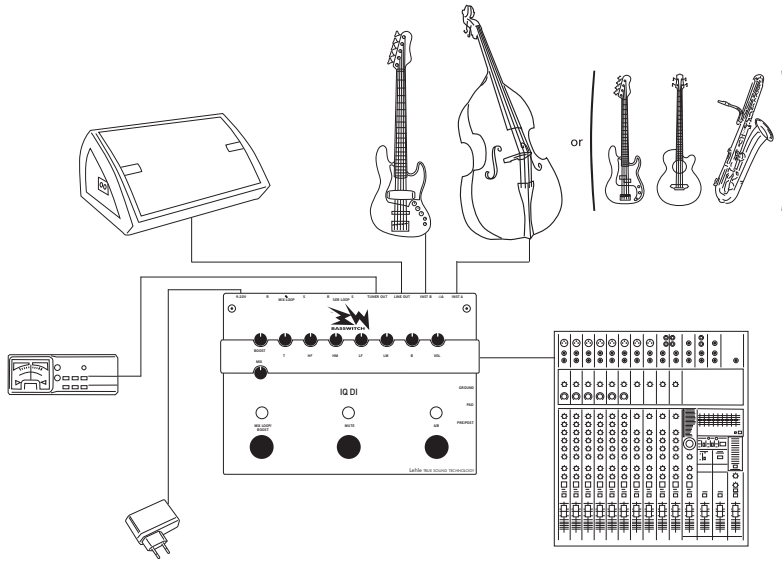

4. The Bassswitch as an AB Switcher/Preamp/Booster/DI on a pedalboard

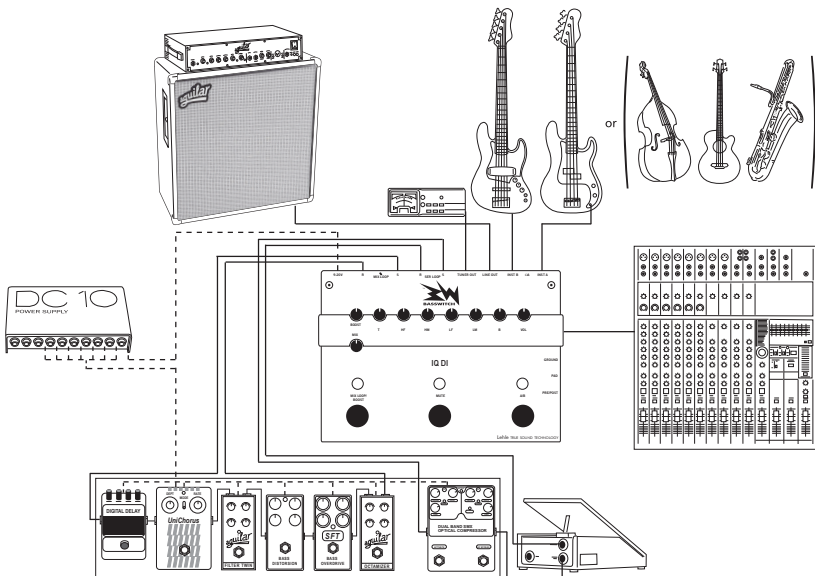

5. The Bassswitch as a Line Mixer

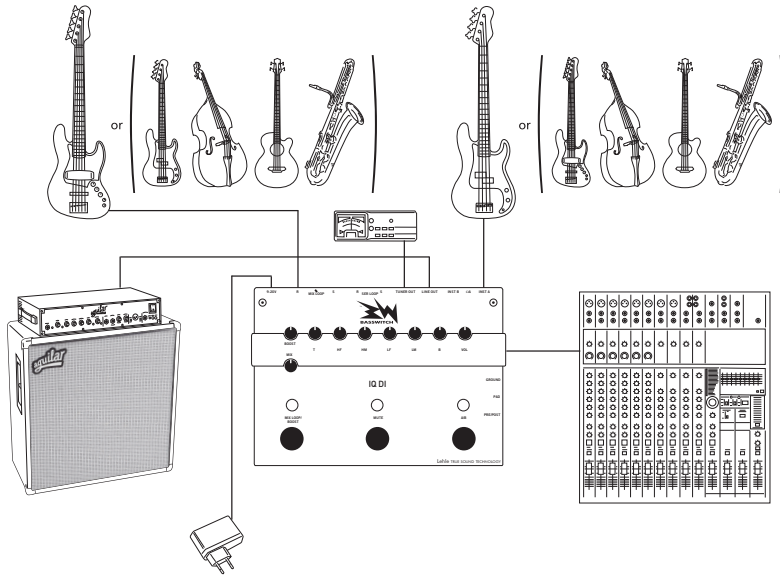

Tech Talk

True Bypass and True Sound

Today more and more effect pedals feature true bypass switching to completely bypass the pedal in the signal routing when the pedal is switched off. The target of this design is to ensure that the pedal does not affect the electrical signal when it is switched off. This way the sound is left unaltered - in theory.

In practice, however, connecting several pedals featuring a true-bypass design in series does not improve the sound or keep it unaltered at all. Long runs of cable and multiple connections lead to a weak and lifeless sound. On large pedalboards the overall length of the cable is enough for the capacitance of the cable have a negative effect on the sound. The capacitance of the cable acts as a low-pass filter (= the low frequencies pass through the filter while the high frequencies are filtered out). The price and quality of the cable you are using will not change this physical phenomenon. A solution would be to use only devices with buffered bypass design instead of true bypass. This, however, is only a good solution if the buffer is of very high quality. If several units with buffered bypass are connected in series it only needs one buffer to be noisy, cut the dynamics of the sound signal or negatively affect the sound in any other way for the sound of the whole effect chain to be spoilt. As the saying goes „a chain is only as strong as its weakest link“. In addition, the noise of the individual buffers adds up to produce audible noise; it is a fact that every buffer produces some noise, even if it cannot be heard when only a single buffer is used.

The ideal solution is to have a very high-quality buffer at the beginning of

the chain that brings the signal down to a very low impedance. This makes the signal insensitive to the length of the cable. It is important, however, that this buffer is of the highest quality with the dynamic range and headroom necessary to ensure that all the details of the bass signal stay are retained unaltered.

The effect pedals in the downstream loops should then ideally have true bypass so that they will not have a negatively effect on the now buffered signal, as the true bypass design does not reduce dynamics and headroom or produce any noise.

Conclusion: Having a True Sound Lehle buffer at the beginning of your effect chain combined with good true-bypass-equipped effects in the loop guarantees the best sound.

What is Lehle True Sound Technology?

Lehle True Sound Technology is a combination of several electrical design measures with only one aim in view: to transmit the sound and the character of the instrument without altering it.

The voltage supplied to the Bassswitch IQ DI is internally rectified, filtered and stabilised and then brought to 18V. Supplying the buffer with 18V gives enough headroom to guarantee an open and dynamic sound in all situations without losing any detail, even when confronted with pick-up power peaks from plus 7 to minus 7 volts. The buffers are designed to effortlessly handle signals reaching the megahertz range. At the output, the frequency bandwidth is limited to the audible frequency range to prevent HF interference, disturbing the electronic circuitry. This guarantees optimal transient response by the circuitry and is key to obtaining a sound that is

transparent and, above all, cuts through. For switching, Lehle True Sound Technology uses exclusively gold-plated contact relays and/or gold-plated switches. The decaying signal from a string is so weak that contact materials with lower conductivity have a negative impact on the sound. Ordinary footswitches use contact materials developed to switch high voltages (e.g. electrical power tools) as this is their main field of application. This can be heard, for example, when, after a switch has been in use for some time, a decaying tone starts to break off abruptly. Relays and switches with gold-plated contacts do not have this problem and even the smallest electrical signals can be transmitted for years without being negatively affected. In addition, the relays used in the Basswitch IQ DI have a lifetime about 100 times as long as those used in ordinary footswitches. Together with typical Lehle electronic circuitry to reduce the switching pop of relays, the combination of the above design features represents today's state-of-the-art solution for an uncompromising preservation of the signal and hence the sound and character of the instrument.

Lehle transformer

The Lehle transformer allows for galvanic isolation at the D.I. output. Only real physical galvanic isolation guarantees complete elimination of ground hum and annoying background noises in any live or studio situation. The Lehle transformer also offers a high level of safety as it isolates the Basswitch IQ DI from current peaks of up to 2,000 V.

Note: Transformers are widely thought to have a negative impact on sound. This does not apply in the case of the Lehle transformer used in the Basswitch IQ DI.

Both the D.I. Out and the Line Out of the Basswitch IQ DI can handle a frequency range from 20Hz to 100KHz (linear). The transformer does not affect the headroom either as levels of up to 16dBu are handled without a problem.

Working principle of the Basswitch IQ DI footswitches

Footswitches are pressed thousands of times during their long lifetimes - sometimes sensitively but some times more brutally depending on the situation and the musician's temperament. An ordinary footswitch will switch up to 20,000 times before wearing out mechanically or electrically, which means that either it will stop working altogether or the signal will start to lose transparency and dynamics.

The Basswitch IQ DI is equipped with high-quality Lehle footswitches. Here the foot of the musician does not press an ordinary footswitch but an actuator button that activates a pushbutton inside the Basswitch IQ DI via a metal lever. Because the actuator button and the internal pushbutton are not directly connected, the load exerted by the foot is absorbed by the actuator button and the housing, preserving the circuit board from mechanical stress. The design is as robust as possible and the actuator button mounted in a special socket making for easy and silent operation.

Inside the Basswitch IQ DI the impulse from the pushbutton activates special gold-plated relays via discrete logic circuitry. This way the switching is done only via high-quality relays and thus guaranteeing absolutely reliable and loss-free switching of very sensitive signals. The switching technology and the gold-plated relays in the Basswitch IQ DI are designed to operate for up to two million switching cycles!

Block Diagram

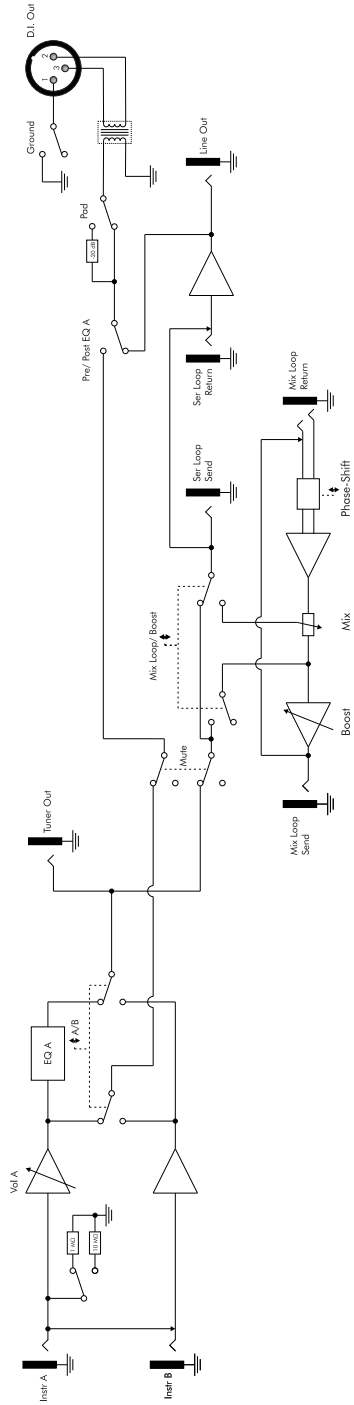

Technical data:

Weight: 1375g
Length: 16,2 cm
Width: 22,0 cm
Overall height: 4,2 cm
Voltage range: 9-20 V AC/DC
Power consumption: max. 130 mA
Frequency range: 20 Hz – 100 KHz (+/- 0,2dB)
Distortion: 0,005 %
Input A impedance: 1 M Ω / 10 M Ω (switchable)
Input B impedance: 1 M Ω
Output impedance: 150 Ω
Signal-to-noise ratio: -94 dB @ 1kHz, 0 dBu (A weighted)
Max. level: 5V RMS (ca. 16 dBu)
Max. gain: +/- 15 dB

EQ

Bass: +/-18 dB @ 33 Hz (peaking)
Low Mid: +/-18 dB @ 90 Hz – 500 Hz (peaking)
High Mid: +/-16 dB @ 840 Hz – 5,6 kHz (peaking)
Treble: +/- 18 dB @12,5 kHz (shelving)

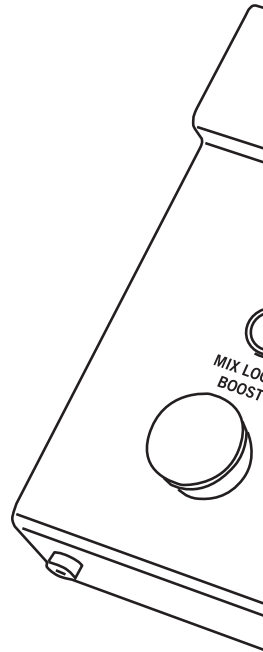

Contact:
Ruppert Musical Instruments
20a, rue de Bascharage
L - 4995 Schouweiler
Luxembourg
Tel./Fax: 00 352 691 379050
Web: www.rmi.lu
E-Mail: jacques@rmi.lu